

MULTI SYSTEM

multi & evo systems

Le celle frigorifere a modularità integrale

The fully modular cold rooms

Les chambres froides à modularité intégrale

Modulare aufgebaute Kühlzellen



Multisystem è una gamma di celle frigorifere modulare ed estensibile.

La sua modularità e completezza di accessori consentono la realizzazione sempre "aganciata" di configurazioni sia semplici che complesse, è modificabile per evoluzioni future e permette l'utilizzo di poche tipologie di pannelli per un grande numero di dimensioni di celle agevolando quei distributori che lavorano a stock di componenti.

Multisystem is a range of fully modular and extendable cold rooms.

Its modularity and the complete range of accessories permit the assembling with camlocks of simple and complicated project, can be extended / partitioned for future needs and permits the use of just a few different types of panels for a large number of cold-rooms dimensions facilitating those distributors who work with stock of panels.

Multisystem est une gamme de chambres frigorifiques modulable et extensible.

Sa modularité et les nombreux accessoires disponibles permettent la réalisation toujours "accrochée" de configurations soit simples que complexes, elle est modifiable pour des évolutions futures et permet l'utilisation de peu de types de panneaux pour un grand nombre de dimensions de chambres froides en facilitant les distributeurs qui travaillent à stock de composants.

Multisystem ist eine Auswahl

an modularen und erweiterbaren Kühlzellen. Ihre Modularbauweise und ihre Vollständigkeit an Zubehör ermöglichen die Ausführung immer durch Hacken von sowohl einfachen als auch komplexen Aufbauten, sie ist für zukünftige Entwicklungen veränderbar, und sie ermöglicht, durch den Gebrauch von wenigen Paneelentypologien zahlreiche Größen von Kühlzellen zu erhalten, was insbesondere für Absatzhändler, die mit Komponentenvorräten arbeiten, vorteilhaft ist.

incold®

MULTI SYSTEM

Le celle frigorifere a modularità integrale - *The fully modular cold rooms*
Les chambres froides à modularité intégrale - *Modulare aufgebaute Kühlzellen*

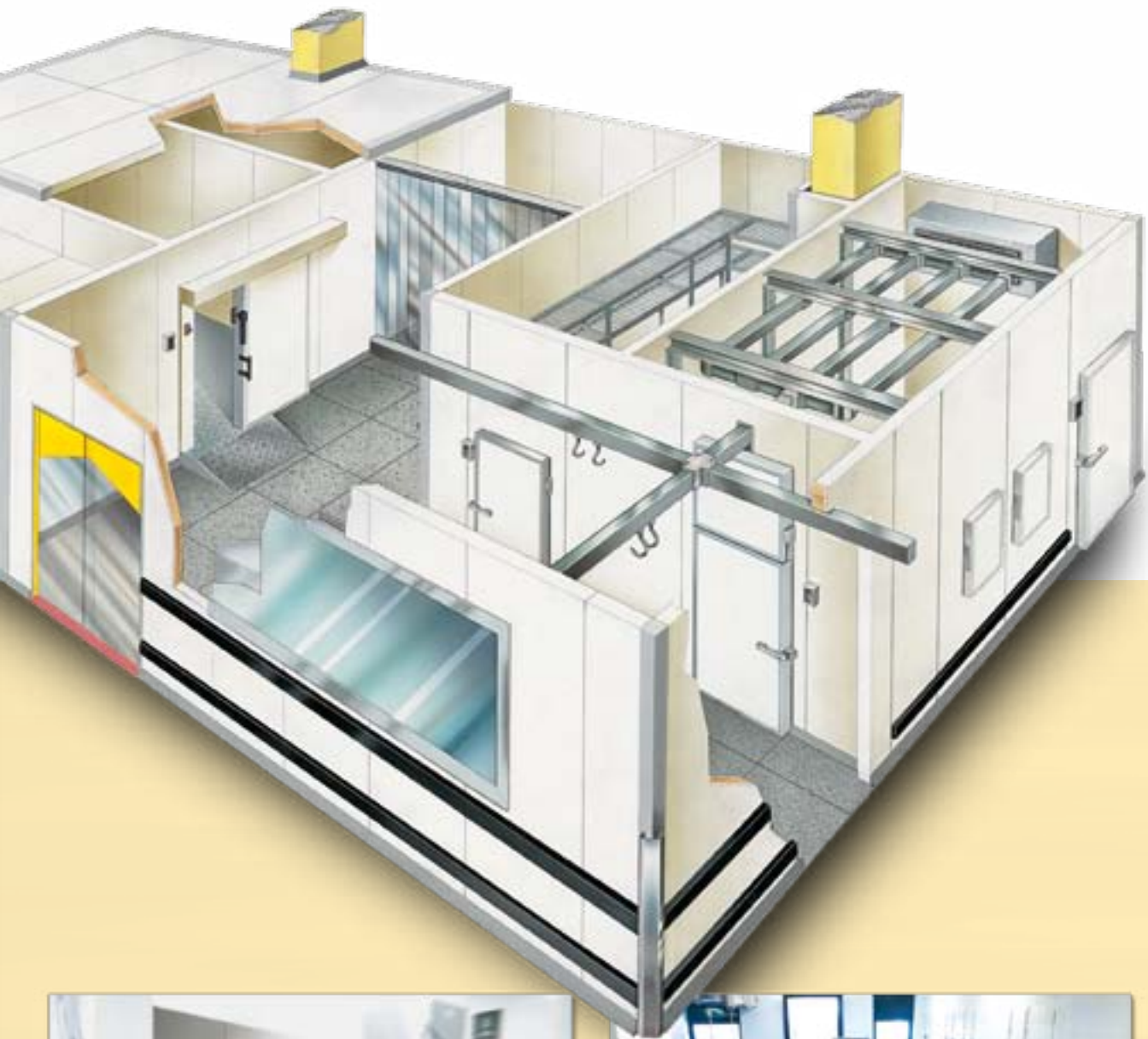

Ristorazione - Restaurants - Restauration - Restaurants



Sale di lavorazione - Food preparation areas - Salles de travail
Raum für Essenvorbereitung



Grande distribuzione - Supermarkets - Grande distribution - Supermärkte



Laboratori - Laboratories - Laboratoires - Laboratorien

MULTI SYSTEM

Le celle frigorifere a modularità integrale - *The fully modular cold rooms*
 Les chambres froides à modularité intégrale - *Modulare aufgebaute Kühlzellen*



I PANNELLI - PANELS - LES PANNEAUX - DIE PANEELE

Tipo sandwich con 2 supporti metallici con interposta schiuma di poliuretano (PUR) rigida. Lamiera zincata preverniciata 30 microns, colore bianco RAL 9010, atossica, con pellicola protettiva temporanea.

Classe di reazione al fuoco standard B s3 d0 secondo norma europea EN 13501-1 equivalente alla classe 2 secondo norma UNI 9177 .

Sandwich panels consisting of rigid polyurethane foam (PUR) inside 2 metal sheets. Prepainted galvanized steel sheet with 30 microns of paint, with colour RAL 9010, non toxic, with temporary protective film.

Reaction to fire, B s3 d0 according to European standard EN 13501-1 corresponding to class 0 according to BS 476 Parts 6 & 7.

Panneau sandwich constitué de deux parements métalliques et d'un noyau de mousse de polyuréthane (PUR) rigide. Tôle galvanisée pré-laqué 30 microns, de couleur blanc RAL 9010, atoxique, avec film de protection temporaire.

Classe de reaction au feu standard B s3 d0 selon norme Européen EN 13501-1 correspondant à la classe M1 selon NF P92-507.

Sandwichpaneele bestehend aus 2 Metallunterlagen mit hartem Polyurethanschaum (PUR). Verzinktes lackiertes ungiftiges Blech 30 Mikrons, Farbe weiß RAL9010, mit wegnehmbarer Schutzfolie.

Standard Feuerreaktionsklasse B s3 d0 gemäß der europäischen Norm EN 13501-1 entsprechend der B1 Klasse gemäß der DIN-Norm 4102.

PUR - 41 kg/m³ - λ 0,023 W/m²K
 Reaction to fire B s3 d0 standard

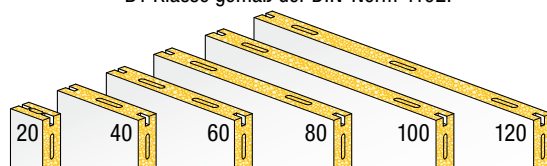

90kg max

GOMMA
 RUBBER
 CAOUTCHOUC
 GUMMI

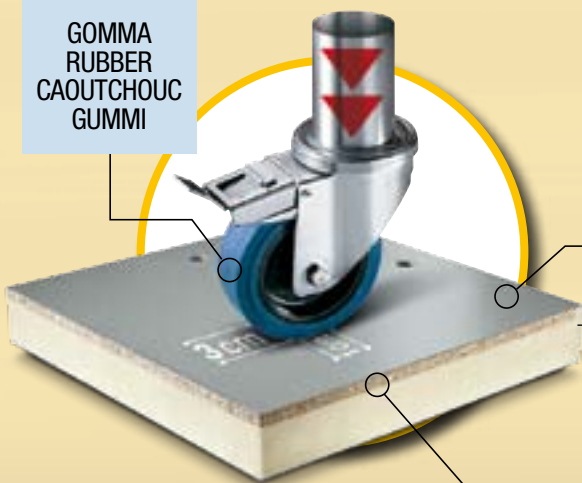

PAVIMENTI - FLOORS SOLS - BODENELEMENTE

Lamiera di acciaio zincato, plastificata con film in PVC rigido 200 micron.

Galvanized sheet steel with grey plastic coating in rigid PVC film 200 micron thick.

Tôle d'acier galvanisée, plastifiée avec film en PVC rigide 200 micron.

Trittfläche aus verzinktem Stahlblech, mit einem harten 200 micron starken, grauen, rutschfesten PVC - Film.

Rinforzo in truciolare spessore 10 mm.

Reinforced with chipboard for a thickness of 10 mm.

Renforcement en bois aggloméré épaisseur 10 mm.

10 mm starker Spanverstärkung plastifiziert.

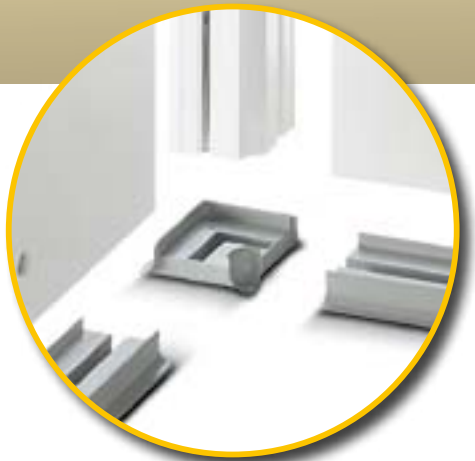
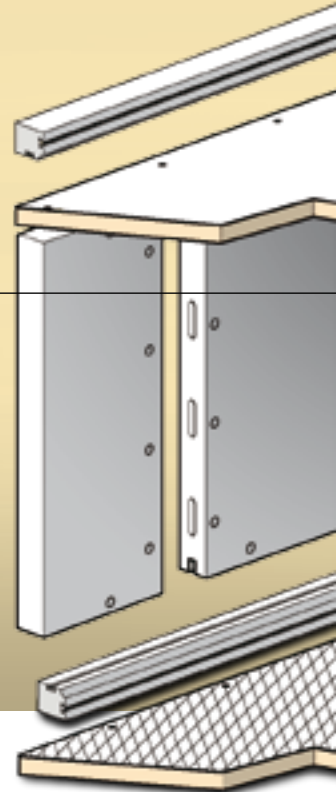

CELLE SENZA PAVIMENTO COLD ROOMS WITHOUT FLOORS CHAMBRES SANS SOL KÜHLZELLEN OHNE BODEN



95 cm
OPTION 60-70-80-120-140 cm

PORTE - DOORS - PORTES - TÜRNEN

Porta standard su pannello con luce netta 95x190 cm incernierata a DX (Sx optional) completa di maniglia con chiave e sblocco interno di sicurezza luminescente. Su richiesta L = 60/70/80/120 cm tutte disponibili anche in versione scorrevole.

Standard door on panel with net opening of 95x190 cm hinged on the right (left optional) complete with handle with key and inside luminescent safety release. On request L = 60/70/80/120 cm all available in the "sliding" version as well.

Porte sur panneau avec passage libre 95x190 cm avec charnière à droite (à gauche en option) complète de poignée avec clé et déblocage intérieur de sécurité luminescent. Sur demande L = 60/70/80/120 cm toutes disponibles dans la version "coulissante" aussi.

Tür am Wandelement mit lichtem Mag 95x190 cm, mit Scharnier an der rechten Seite (an der linken Seite auf Anfrage), komplett mit Griff mit Schlüssel und innerem leuchtendem Notentriegelung. Auf Anfrage B = 60/70/80/120 cm alle auch in der Schiebeausführung zur Verfügung.



95 cm
OPTION 60-70-80-120 cm

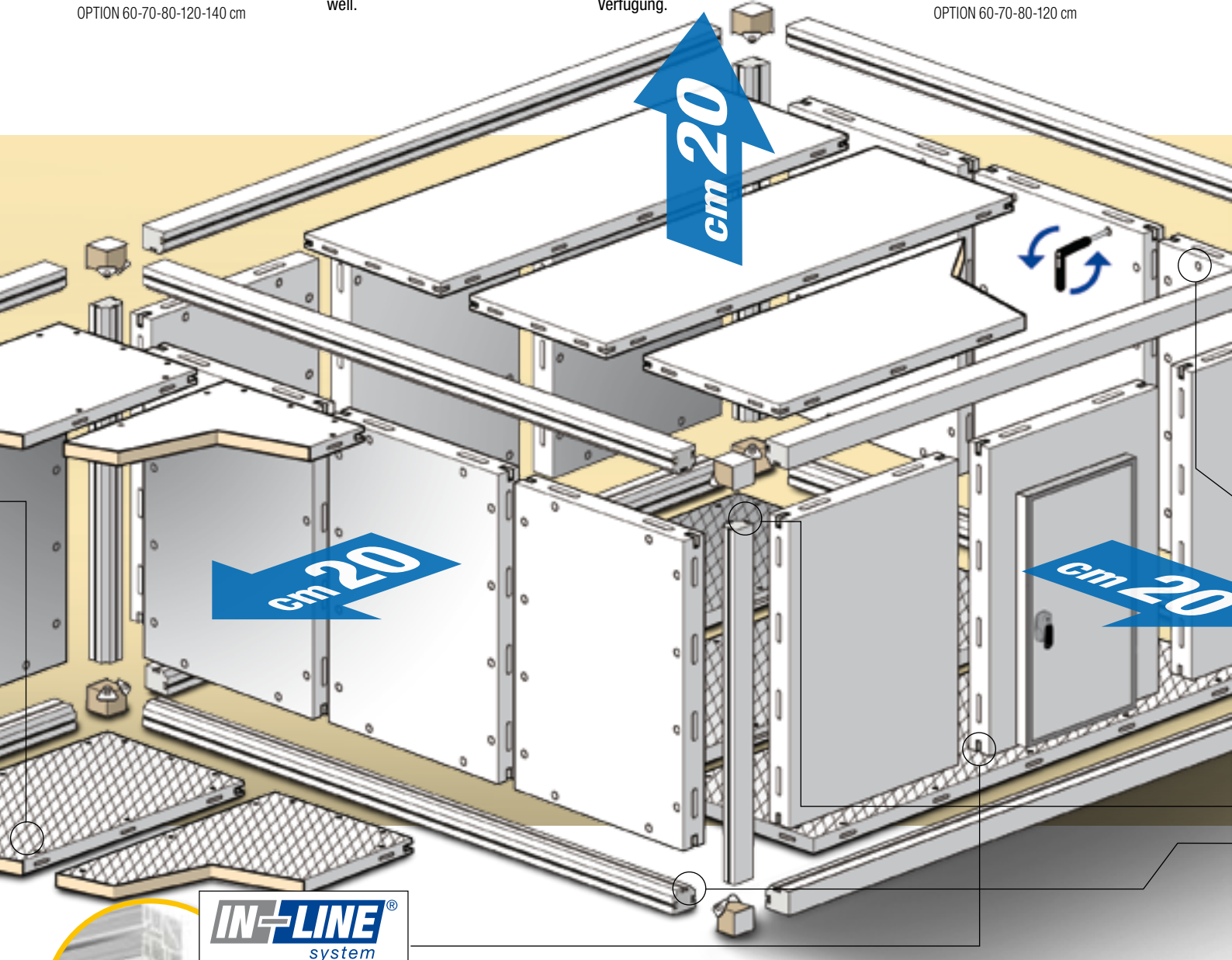

Nuovo sistema brevettato per un rapido e preciso allineamento tra pannelli e giunti d'angolo. Aumenta, inoltre, la portata del soffitto e ne facilita il montaggio

New patented system for rapid and accurate alignment between panels and corner joints. Also increases the load capacity of the ceiling and facilitates assembly.

Nouveau système breveté pour un alignement rapide et précis entre les panneaux et les joints d'angle. Il augmente, en outre, la capacité du plafond et il facilite son assemblage.

Neues patentiertes System für ein schnelles und präzises Ausrichten von Wandelementen und Eckverbindungen. Es erhöht ferner die Tragfähigkeit der Decke und erleichtert die Montage.

CARATTERISTICHE STANDARD PRINCIPALI

MAIN STANDARD FEATURES • CARACTÉRISTIQUES PRINCIPALES STANDARD • WICHTIGSTE STANDARDEIGENSCHAFTEN

5 ALTEZZE STANDARD

5 standard heights
5 hauteurs standard
5 Standardhöhen

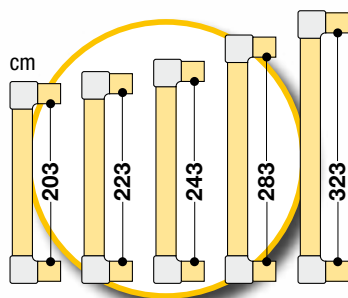

4 SPESSORI

4 Thicknesses
4 Epaisseurs
4 Stärken

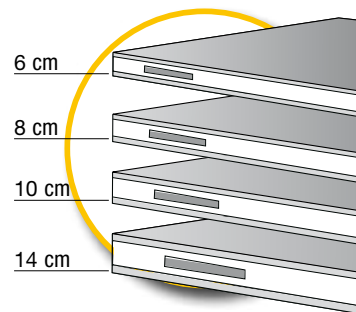

UNIONE CON GANCI ECCENTRICI A DOPPIO EFFETTO

Connection with dual effect camlocks
Union par crochets excentriques à double effet
Verbindung mit exzentrischen Doppeleffekthaken

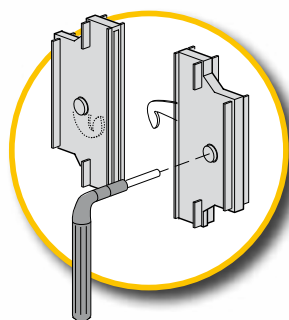

ANGOLI ARROTONDATI INTERNI

Rounded internal corners
Angles intérieurs arrondis
Abgerundete Innenecken

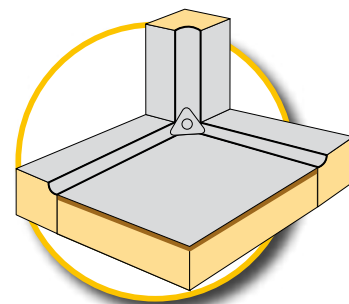

ANGOLARI - EDGE PROFILES POTEAUX D'ANGLE - ECKPROFILE

2 VIE - 2 WAYS
2 DIRECTIONS - 2 WEGE

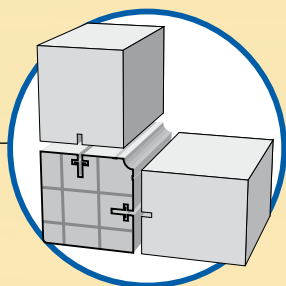

3 VIE - 3 WAYS
3 DIRECTIONS - 3 WEGE

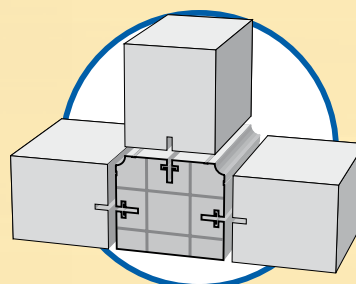

3 VIE RACCORDATO
3 WAY CONNECTION
3 DIRECTIONS RACCORDÉ
3 WEGE VERBUNDEN

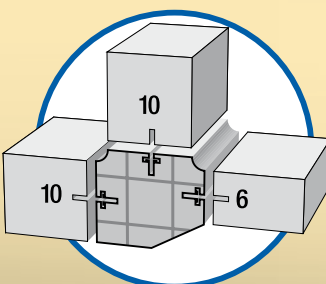

-30°C

• linee isoterliche • sothermal lines
• lignes isothermiques • isothermische Linien



Università degli Studi di Udine
dipartimento di energetica e macchine

Profilato in PVC antiurto a struttura alveolare con sistema d'aggancio universale testato per impiego fino a -30°C.

Section bars in impact-resistant PVC with honeycomb structure and universal connection system tested for use at temperatures as low as -30°C.

Profilé en PVC antichoc à structure alvéolaire avec système d'accrochage universel testé pour une utilisation jusqu'à -30°C.

Stoßfeste PVC-Profile mit Wabenstruktur und universellem Befestigungssystem, das für einen Einsatz bis zu -30°C getestet wurde.



SUPPORTI MOBILI PER AGEVOLARE IL MONTAGGIO DEI SOFFITTI

Mobile supports to help the assembly of the ceiling.
Supports amovibles pour faciliter l'installation du plafond.
Bewegliche Stützen, um die Montage der Decke zu erleichtern.

 incold®

Options

RIVESTIMENTO PANNELLI - PANELS FINISHING REVÊTEMENT PANNEAUX - PANEELEAUSFÜHRUNG

OPTION PL

Lamiera di acciaio zincato, plastificato con film in PVC rigido dello spessore di 120 micron bianco, atossico con pellicola protettiva.

Galvanized sheet steel with plastic coating in rigid white PVC 120 micron thick, non-toxic, with protective film.

Tôle d'acier galvanisée plastifiée avec film en PVC rigide d'épaisseur de 120 micron blanc, atoxique avec pellicule de protection.

Verzinktes Stahlblech, mit weißem, hartem, ungiftigem und 120 micron starkem PVC-Film plastifiziert, mit Schutzfilm.

OPTION IX

Lamiera INOX AISI 304, finitura SCOTCH BRITE con pellicola protettiva.

AISI 304 stainless sheet steel, finished with SCOTCH-BRITE treatment with protective film.

Tôle INOX AISI 304, finition SCOTH BRITE avec pellicule de protection.

Blech aus CHROMNICKELSTAHL 1.4301, Scotch-Brite- Oberflächenausführung mit Schutzfilm.

OPTION PX

Lamiera INOX AISI 304, plastificato con film di PCVC rigido dello spessore di 120 micron bianco, atossico con pellicola protettiva.

AISI 304 stainless sheet steel with plastic coating in rigid white PVC 120 micron thick, non-toxic, with protective film.

Tôle INOX AISI 304, plastifiée avec film en PCVC rigide l'épaisseur de 120 micron blanc, atoxique avec pellicule de protection.

Blech aus CHROMNICKELSTAHL 1.4301 mit weißem, hartem, ungiftigem und 120 micron starkem PVC- Film plastifiziert, mit Schutzfilm.



PAVIMENTI - FLOORS - SOLS - BODENELEMENTE

90kg max

OPTION IR

INOX AISI 304, antisdrucchiolo con certificato R11

AISI 304 stainless steel, non-slip with R11 certificate

INOX AISI 304, antidérapant certifié R11

Rutschfester CHROMNICKELSTAHL 1.4301 mit R11- Zertifikat

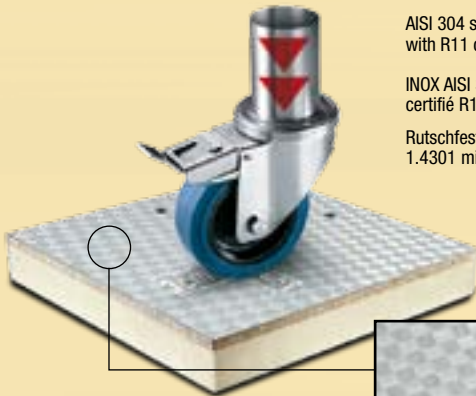

240kg max

OPTION ST

Stratificato fenolico, integrato nella schiuma in poliuretano. Carrellabilità massima Kg 240 per ruota gommata.

Stratified molded phenol integrated into the polyurethane foam. Maximum load 240 kg per rubber wheel.

Stratifié phénolique moulé, intégré dans la mousse en polyuréthane. Capacité maximum de 240 kg par roue caoutchoutée.

Gepresstes Phenollaminat, im PUR- Schaum integriert. Maximale Tragfähigkeit pro Gummirad 240 Kg.

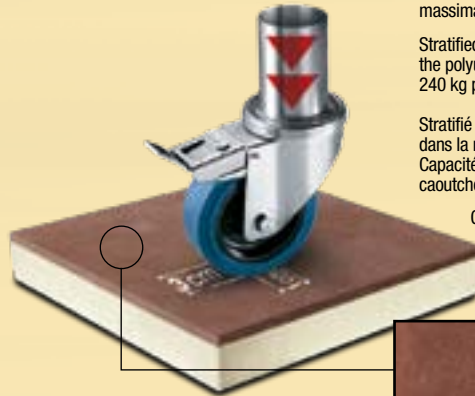

SOGLIE - THRESHOLD - SEUILS - SCHWELLEN

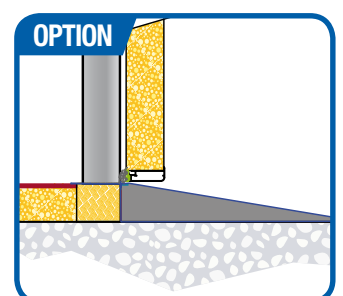
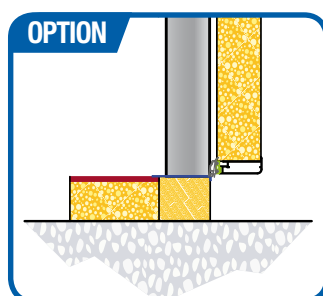
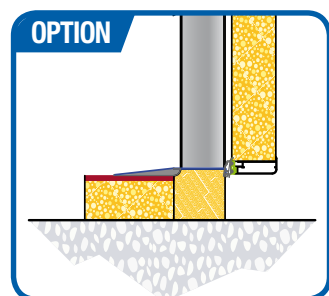
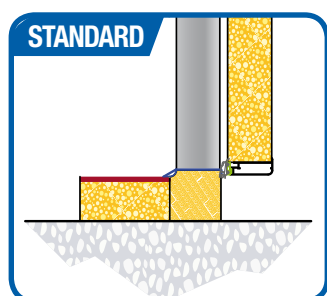

Con rampa interna - With internal ramp
Avec rampe intérieure - Mit Innererrampe

A filo - Floor level
Affleurant - Bodenbündige

A filo con rampa esterna - Floor level with external ramp
Affleurant avec rampe extérieure - Bodenbündige mit Außenrampe

OPTION

multi L

Angolare composto da 2 gusci in lamiera con poliuretano interno e sistema d'aggancio universale testato per impiego fino a -30°C

Edge profile consisting of 2 shells in sheet metal with polyurethane on the inside and universal connection system tested for use at temperatures as low as -30°C

Poteau d'angle composé de 2 coques en tôle avec polyuréthane intérieur et système d'accrochage universel testé pour une utilisation jusqu'à -30°C.

Eckprofil bestehend aus 2 mit Polyurethan gefüllten Blechschalen und einem universellem Befestigungssystem, das für einen Einsatz bis zu -30°C getestet wurde

PORTE A VETRO - GLASS DOORS - PORTES VITRÉES - GLASTÜREN

Multi - Multi L

con porte a vetro - with glass doors
avec portes vitrées - mit Glastüren

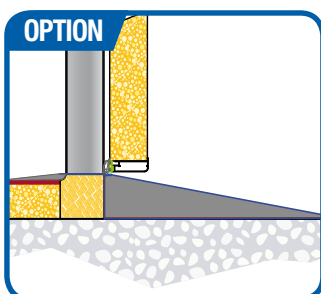

Con rampa interna ed esterna - With internal and external ramp - Avec rampe intérieure et extérieure - Mit innerer und äußerer Rampe

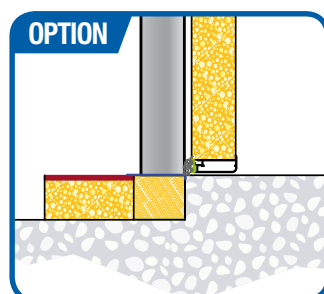

Soglia filo con pavimento incassato - Threshold on floor level, with embedded floor - Seuil à niveau du sol, avec sol encaissé - Bodenbündige Schwelle, mit versenktem Boden



MULTI SYSTEM

Le celle frigorifere a modularità integrale - The fully modular cold rooms
Les chambres froides à modularité intégrale - Modulare aufgebaute Kühlzellen

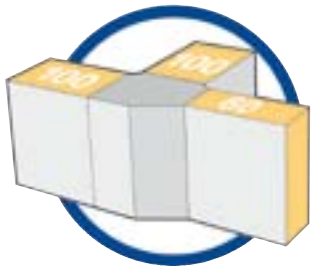

CELLE DIVISE IN PIÙ LOCALI - ROOMS WITH SEVERAL PARTITIONS CHAMBRES DIVISÉES EN PLUSIEURS LOCAUX - KÜHLZELLEN IN MEHRERE RÄUME GETEILT

DETTAGLI E POSSIBILITÀ DI ACCOPPIAMENTO - DETAILS AND POSSIBILITIES OF CONNECTION
DÉTAILS ET POSSIBILITÉ D'ACCOUPEMENT - DETAILS UND VERBINDUNGSMÖGLICHKEITEN

Applicazione divisorio **NON MODULARE** nella cella con stessa temperatura.

Application of **NON-MODULAR** dividing wall in room with the same temperature.

Application cloison **NON MODULAIRE** dans la chambre avec la même température.

Anbringung einer **FLEXIBLEN** Trennwand in der Kühlzelle mit der gleichen Temperatur.



ACCOPPIAMENTO AGGANCIATO DI CELLE CON DIVISORIO MODULARE

Connection with camlocks of rooms with modular dividing wall.

Accouplement accroché de chambres avec cloison modulaire.

Hakenverbindung von Zellen mit stationärer Trennwand.

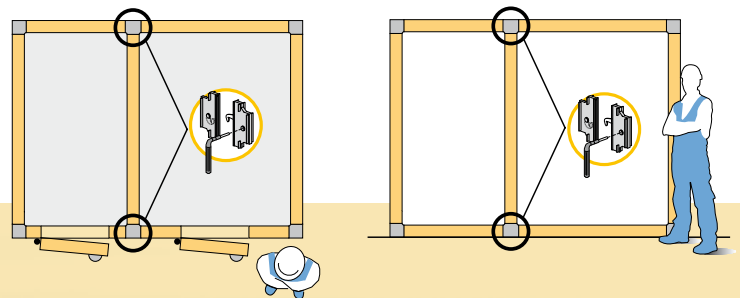

ACCOPPIAMENTO AGGANCIATO E MODULARE DI CELLE CON PAVIMENTO E DI DIVERSO SPESSORE

Modular connection with camlocks of rooms with floor and of different thickness.

Accouplement accroché et modulaire de chambres avec sol et d'épaisseur différente.

Modulare Hakenverbindung von Zellen mit Bodenpaneelen und verschiedenen Stärken.

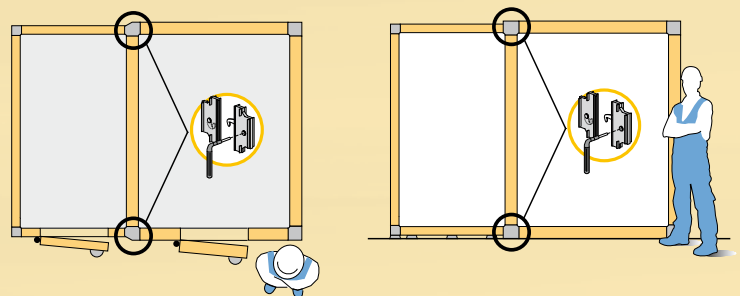

ACCOPPIAMENTO AGGANCIATO E MODULARE DI CELLE CON PAVIMENTO E ALTEZZE DIVERSE

Modular connection with camlocks of rooms with floor and different heights.

Accouplement accroché et modulaire de chambres avec sol et hauteurs différentes.

Modulare Hakenverbindung von Zellen mit Bodenpaneelen und verschiedenen Höhen.

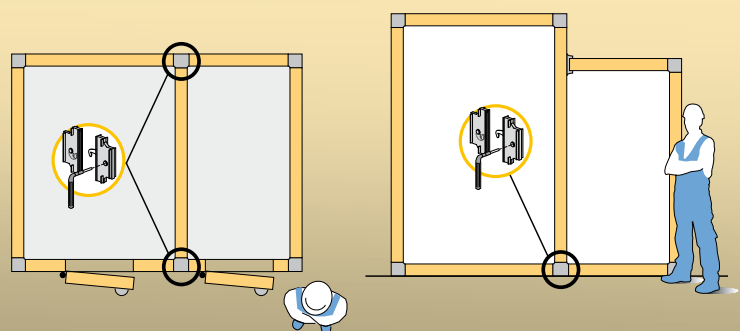

ACCOPPIAMENTO AGGANCIATO E MODULARE DI CELLE DI SPESSORE E ALTEZZE DIVERSE CON E SENZA PAVIMENTO

Modular connection with camlocks of rooms with different heights and thicknesses with and without floor.

Accouplement accroché et modulaire de chambres d'épaisseur et hauteurs différentes avec et sans sol.

Modulare Hakenverbindung von Zellen mit verschiedenen Stärken und Höhen, mit oder ohne Bodenpaneelen.

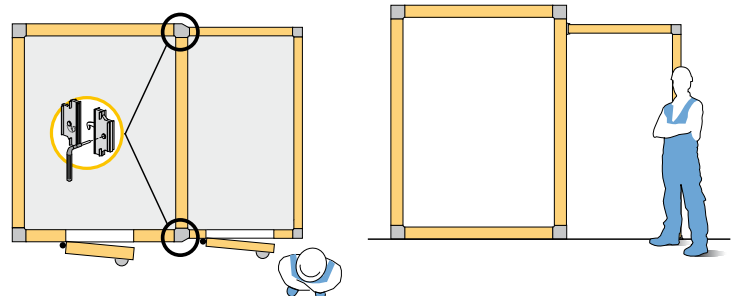

MODULARITÀ E DIMENSIONI - MODULARITY AND DIMENSIONS MODULARITÉ ET DIMENSIONS - MODULBAUWEISE UND ABMESSUNGEN

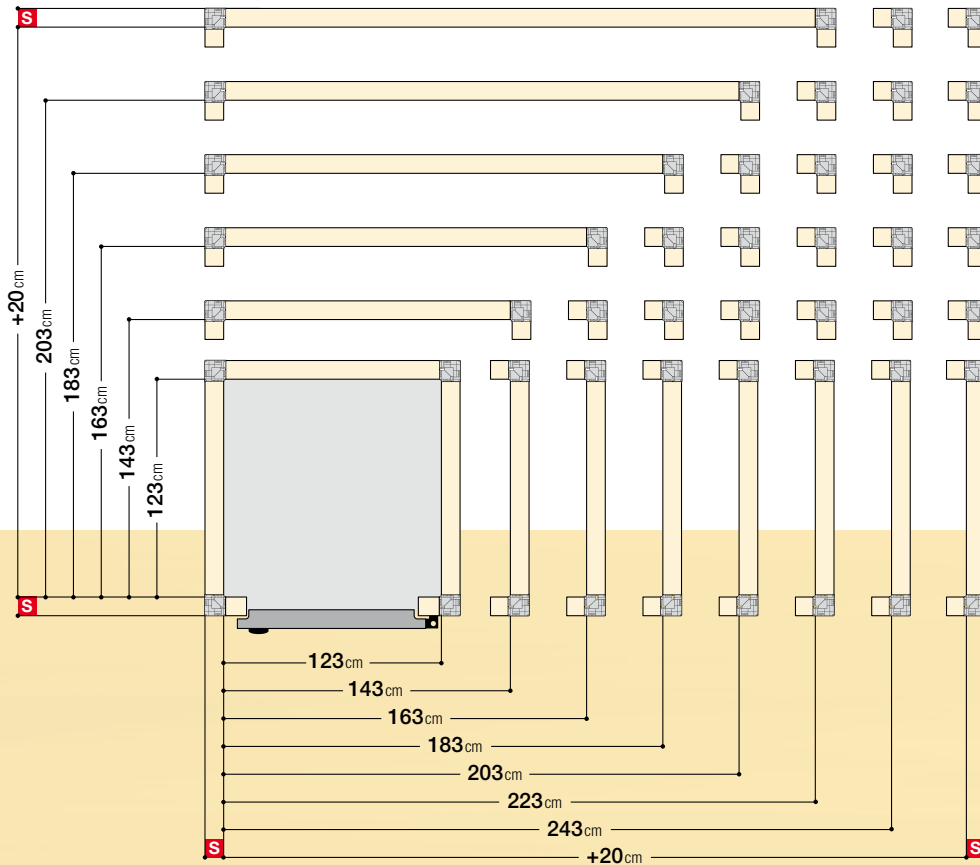

5 ALTEZZE STANDARD

5 standard heights - 5 hauteurs standard - 5 Standardhöhen

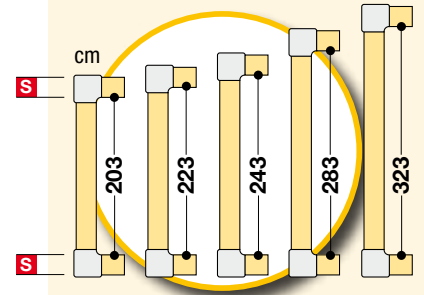

Commercio - Small retailers - Commerces - Kleine Geschäfte



Locali industriali - Industrial premises - Locaux industriels - Industrielle Gebiete

MULTI SYSTEM

Le celle frigorifere a modularità integrale - *The fully modular cold rooms*
 Les chambres froides à modularité intégrale - *Modulare aufgebaute Kühlzellen*

ACCESSORI ACCESSORIES ACCESSOIRES ZUBEHÖR



easyrack

Scaffalatura alluminio/polietilene - *Shelving in aluminium and polythene*
 Rayonnage en aluminium et polythène - *Regalsystem aus Aluminium und Polyäthylen*



1600 mm
1750 mm
1900 mm

300 mm
400 mm
500 mm



I INCOLD S.p.A. si riserva il diritto, per ragioni tecniche e commerciali, di apportare in qualsiasi momento e senza preavviso, modifiche ritenute necessarie.

GB INCOLD S.p.A reserves the right to bring any change considered necessary, both on technical and commercial ground, at any time and without notice.

F INCOLD S.p.A. se réserve le droit d'apporter à cette documentation, pour raisons techniques et commerciales, à n'importe quel moment et sans préavis, toutes les modifications qui sont considérées nécessaires.

D INCOLD S.p.A. behält sich das Recht vor, aus technischen und Geschäftsgründen, jederzeit und ohne Voranzeige alle erforderlichen Änderungen vorzunehmen.



INCOLD Spa - Via Grandi, 1 - 45100 ROVIGO
 Tel +39 0425 39 66 66 - Fax +39 0425 39 66 00
 www.incold.it - e-mail: incold@incold.it

MOD.ITD - Info Tecniche MULTI & EVO system
 DATA: 05/2015

REV. N° 05

